



# Kovani okov

*Željezo se kroz povijest pokazalo kao izvrstan materijal za izradu i dizajn cijelog niza predmeta, od svakodnevene do specijalizirane upotrebe.*

# Brojevi i slova



ŠIFRA	NAZIV ARTIKLA	KATALOŠKI BROJ	DIMENZIJE (mm)
14528	Broj kovani BNM -0	2520001900	A 105
14529	Broj kovani BNM -1	2521001900	A 105
14530	Broj kovani BNM -2	2522001900	A 100
14531	Broj kovani BNM -3	2523001900	A 105
14532	Broj kovani BNM -4	2524001900	A 115
14533	Broj kovani BNM -5	2525001900	A 115
14534	Broj kovani BNM -6	2526001900	A 103
14535	Broj kovani BNM -7	2527001900	A 100
14536	Broj kovani BNM -8	2528001900	A 105
14537	Broj kovani BNM -9	2529001900	A 103
14581	Slovo kovano BAP -A	2650001900	A 84
14582	Slovo kovano BAP -B	2651001900	A 80
14583	Slovo kovano BAP -C	2652001900	A 85
14584	Slovo kovano BAP -D	2653001900	A 80

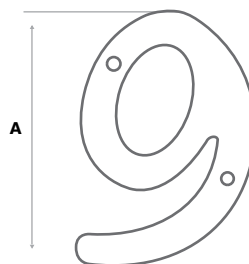

## Ručkica BBP-002



ŠIFRA	NAZIV ARTIKLA	KATALOŠKI BROJ	DIMENZIJE (mm)
16310	Ručkica kovana BBP-002 školjka	2812001900	A 38 B 102

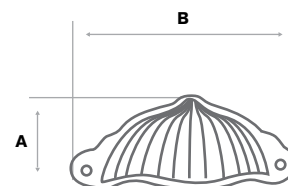

## Ručkica BBP-004



ŠIFRA	NAZIV ARTIKLA	KATALOŠKI BROJ	DIMENZIJE (mm)
16309	Ručkica kovana BBP-004 školjka	2814001900	A 50 B 95

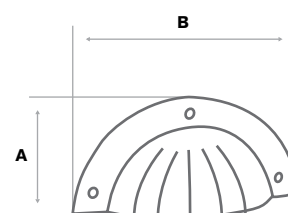

## Ručkica BBP-006



ŠIFRA	NAZIV ARTIKLA	KATALOŠKI BROJ	DIMENZIJE (mm)
14577	Ručkica kovana BBP-006 školjka	2816001900	A 44 B 100

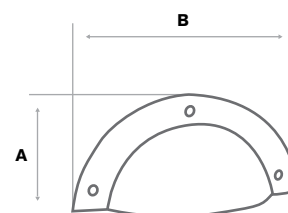

## Ručkica BCF-025



ŠIFRA	NAZIV ARTIKLA	KATALOŠKI BROJ	DIMENZIJE (mm)
14567	Ručkica kovana BCF-025	2825001900	A 66 B 110

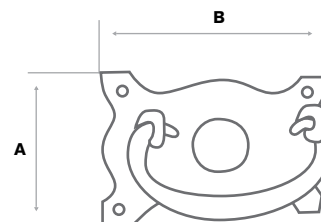

## Ručkica BCF-002



ŠIFRA	NAZIV ARTIKLA	KATALOŠKI BROJ	DIMENZIJE (mm)
14562	Ručkica kovana BCF-002	2802001900	A 55 B 117

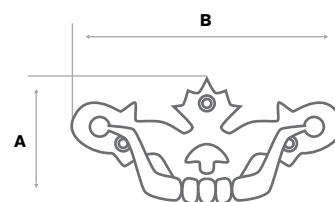

## Ručkica BCF-026



ŠIFRA	NAZIV ARTIKLA	KATALOŠKI BROJ	DIMENZIJE (mm)
14568	Ručkica kovana BCF-026 sa alkom	2826001900	A 60 B 37,5

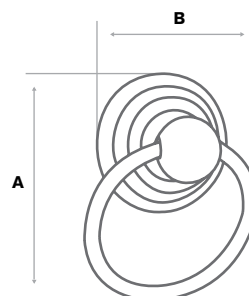

## Ručkica BCK-001



ŠIFRA	NAZIV ARTIKLA	KATALOŠKI BROJ	DIMENZIJE (mm)
14538	Ručkica kovana BCK-001	2841001900	A 32 B 36,5

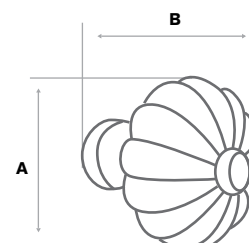

## Ručkica BCK-013



ŠIFRA	NAZIV ARTIKLA	KATALOŠKI BROJ	DIMENZIJE (mm)
14543	Ručkica kovana BCK-013	2853001900	A 33 B 34

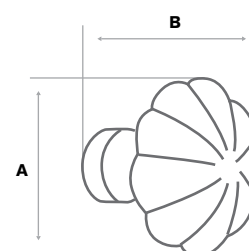

## Ručkica BCK-004



ŠIFRA	NAZIV ARTIKLA	KATALOŠKI BROJ	DIMENZIJE (mm)
14539	Ručkica kovana BCK-004	2844001900	A 40 B 28

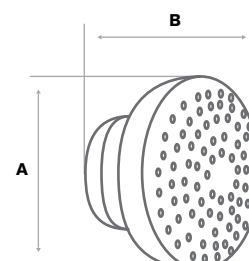

## Ručkica BCK-010



ŠIFRA	NAZIV ARTIKLA	KATALOŠKI BROJ	DIMENZIJE (mm)
14542	Ručkica kovana BCK-010	2850001900	A 32 B 32

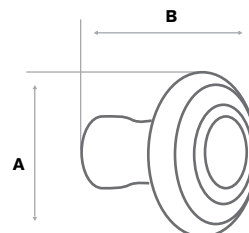

## Ručkica BCK-007



ŠIFRA	NAZIV ARTIKLA	KATALOŠKI BROJ	DIMENZIJE (mm)
14540	Ručkica kovana BCK-007	2847001900	A 35 B 32

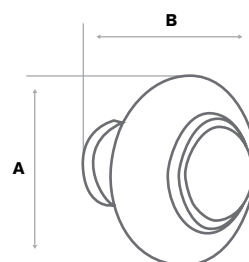

## Spojnica BCH-001



ŠIFRA	NAZIV ARTIKLA	KATALOŠKI BROJ	DIMENZIJE (mm)
14570	Spojnica kovana BCH-001	2904001900	A 70 B 42 C 4

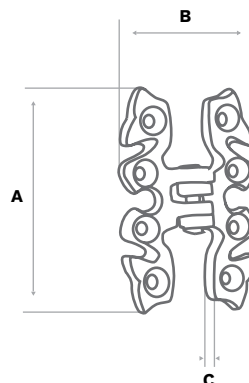

## Štit stilski BKE-001



ŠIFRA	NAZIV ARTIKLA	KATALOŠKI BROJ	DIMENZIJE (mm)
14569	Štit stilski kovani BKE-001	2902001900	A 42 B 31 C 4

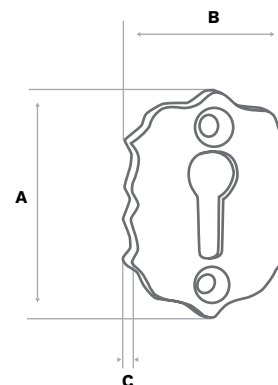

## Zakovica BDS-001



ŠIFRA	NAZIV ARTIKLA	KATALOŠKI BROJ	DIMENZIJE (mm)
14572	Zakovica kovana BDS-001 sa vijkom	2906001900	A 23 B 23 C 25

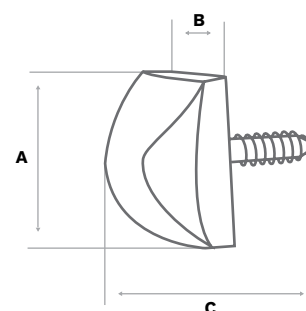

## Kugla BCD-001



ŠIFRA	NAZIV ARTIKLA	KATALOŠKI BROJ	DIMENZIJE (mm)
14571	Kugla kovana BCD-001 fiksna	2905001900	A 65 B 65 C 55

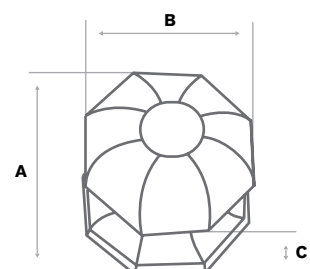

# Ručka BMS-001/002



ŠIFRA	NAZIV ARTIKLA	KATALOŠKI BROJ	DIMENZIJE (mm)
14546	Ručka kovana BMS-001	2401001900	A 170 B 54 C 33
14547	Ručka kovana BMS-002	2402001900	A 260 B 59 C 48

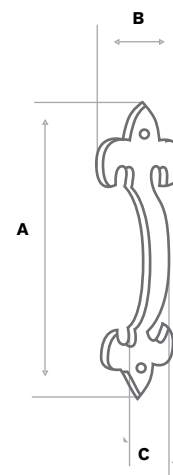

# Ručka BMS-005



ŠIFRA	NAZIV ARTIKLA	KATALOŠKI BROJ	DIMENZIJE (mm)
14548	Ručka kovana BMS-005	2405001900	A 180 B 40 C 32

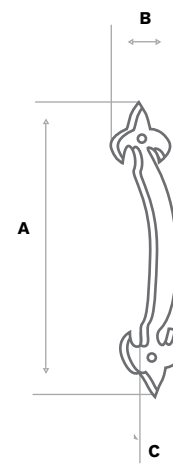



# Ručka BPH-002



ŠIFRA	NAZIV ARTIKLA	KATALOŠKI BROJ	DIMENZIJE (mm)
14561	Ručka kovana BPH-002	2400001900	A 250 B 53 c 42

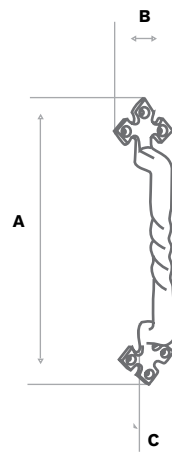

# Zasun BMS-031



ŠIFRA	NAZIV ARTIKLA	KATALOŠKI BROJ	DIMENZIJE (mm)
14549	Zasun kovani BMS-031 sa zatvaračem	2431001900	A 130 B 40 c 33

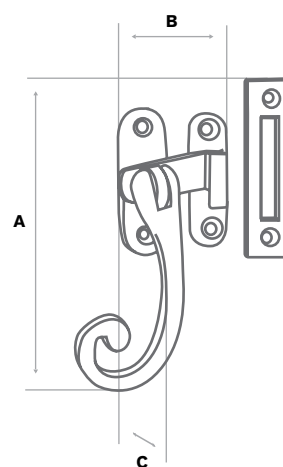

## Zasun BDB-001/002



ŠIFRA	NAZIV ARTIKLA	KATALOŠKI BROJ	DIMENZIJE (mm)
14573	Zasun kovani BDB-001	2909001900	A 145 B 42 c 24
14574	Zasun kovani BDB-002	2910001900	A 235 B 40 c 31

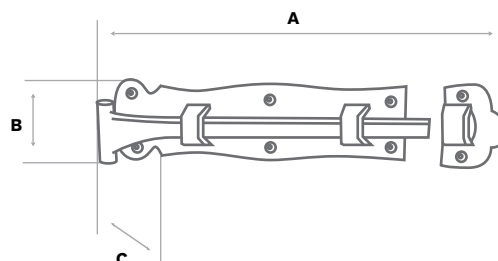

## Zasun BDB-009/010



ŠIFRA	NAZIV ARTIKLA	KATALOŠKI BROJ	DIMENZIJE (mm)
14576	Zasun kovani BDB-009	2913001900	A 87 B 32 c 28
14578	Zasun kovani BDB-010	2914001900	A 110 B 32 c 36

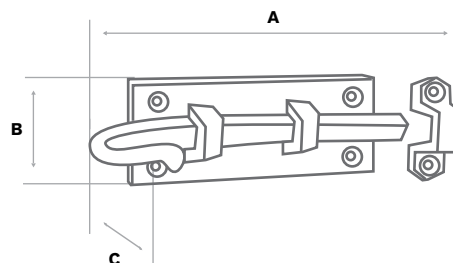

## Zasun BDB-005



ŠIFRA	NAZIV ARTIKLA	KATALOŠKI BROJ	DIMENZIJE (mm)
14575	Zasun kovani BDB-005	2911001900	A 87 B 32 c 30

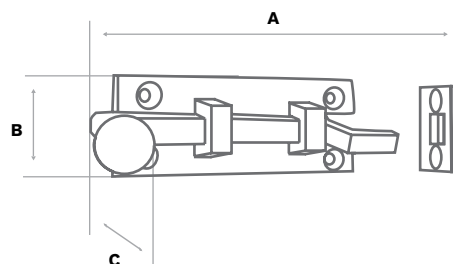



## Udarač za vrata BDK-008



ŠIFRA	NAZIV ARTIKLA	KATALOŠKI BROJ	DIMENZIJE (mm)
14526	Udarač za vrata kovani BDK-008	2208001900	A 140 B 106 c 35

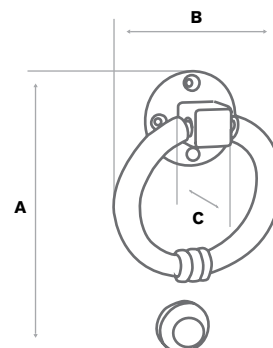

## Udarač za vrata BDK-005



ŠIFRA	NAZIV ARTIKLA	KATALOŠKI BROJ	DIMENZIJE (mm)
14527	Udarač za vrata kovani BDK-005	2205001900	A 168 B 95 c 36

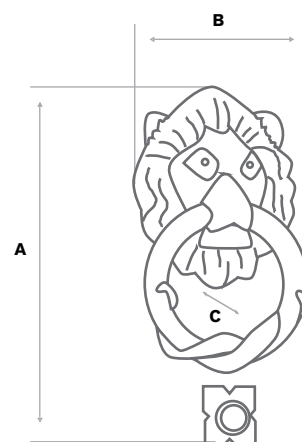

## Vješalica BDH-001



ŠIFRA	NAZIV ARTIKLA	KATALOŠKI BROJ	DIMENZIJE (mm)
14550	Vješalica kovana BDH-001 mala	2701001900	A 57 B 24 c 40

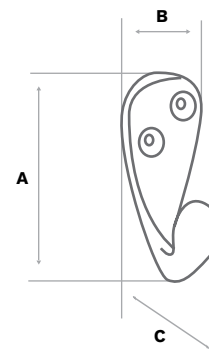

## Vješalica BDH-002



ŠIFRA	NAZIV ARTIKLA	KATALOŠKI BROJ	DIMENZIJE (mm)
14551	Vješalica kovana BDH-002 mala	2702001900	A 55 B 77 c 33

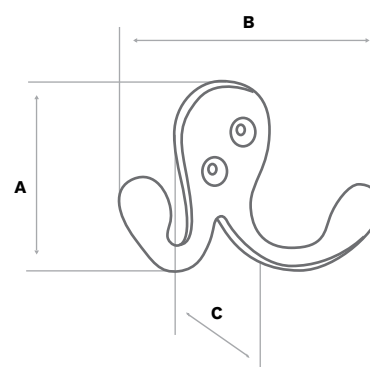

## Vješalica BDH-003



ŠIFRA	NAZIV ARTIKLA	KATALOŠKI BROJ	DIMENZIJE (mm)
14552	Vješalica kovana BDH-003 mala	2703001900	A 50 B 40 c 63

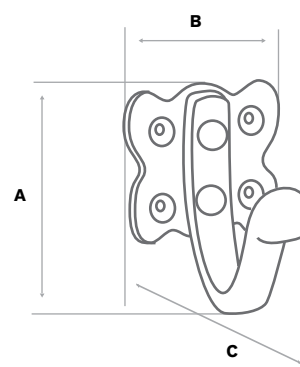

## Vješalica BDH-005



ŠIFRA	NAZIV ARTIKLA	KATALOŠKI BROJ	DIMENZIJE (mm)
14553	Vješalica kovana BDH-005 velika	2705001900	A 142 B 43 C 77

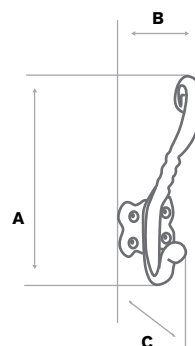

## Vješalica BDH-006



ŠIFRA	NAZIV ARTIKLA	KATALOŠKI BROJ	DIMENZIJE (mm)
14554	Vješalica kovana BDH-006 velika	2706001900	A 127 B 35 C 75

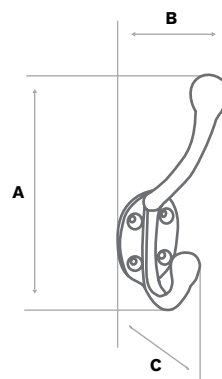

## Vješalica BDH-009



ŠIFRA	NAZIV ARTIKLA	KATALOŠKI BROJ	DIMENZIJE (mm)
14555	Vješalica kovana BDH-009 2/1	2709001900	A 105 B 40 C 65

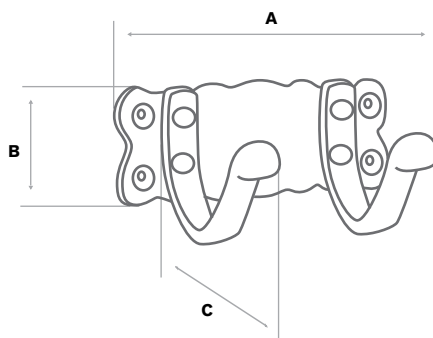

## Vješalica BDH-010



ŠIFRA	NAZIV ARTIKLA	KATALOŠKI BROJ	DIMENZIJE (mm)
14556	Vješalica kovana BDH-010 3/1	2710001900	A 152 B 40 c 65

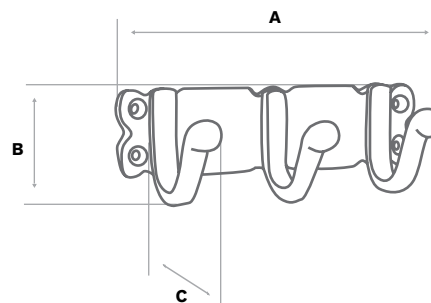

## Kuka BDH-020/021



ŠIFRA	NAZIV ARTIKLA	KATALOŠKI BROJ	DIMENZIJE (mm)
14558	Kuka kovana BDH-020	2720001900	A 160 B 42 c 24
16311	Kuka kovana BDH-021	2721001900	A 110 B 42 c 18

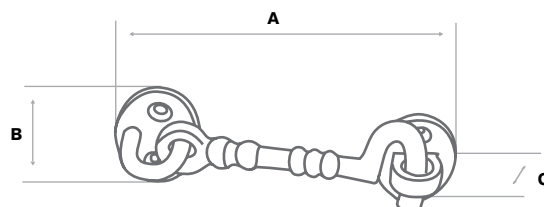

## Kuka BDH-030/031



ŠIFRA	NAZIV ARTIKLA	KATALOŠKI BROJ	DIMENZIJE (mm)
14559	Kuka kovana BDH-030 / 100mm	2730001900	A 105 B 60 c 31
14560	Kuka kovana BDH-031 / 160mm	2731001900	A 155 B 60 c 31

